

- ^{ぶんどき}分度器の中心を点アに合わせて次の角度をかきましょう。

1 100°

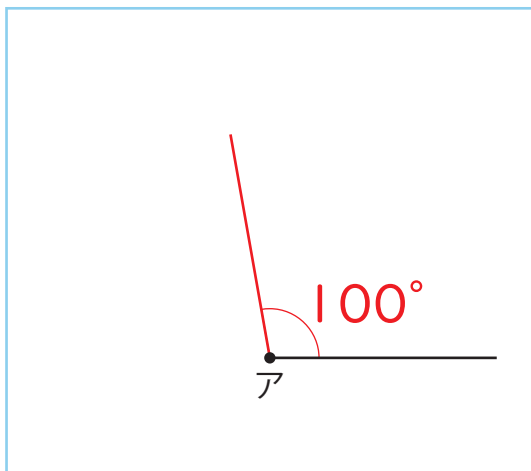

2 170°

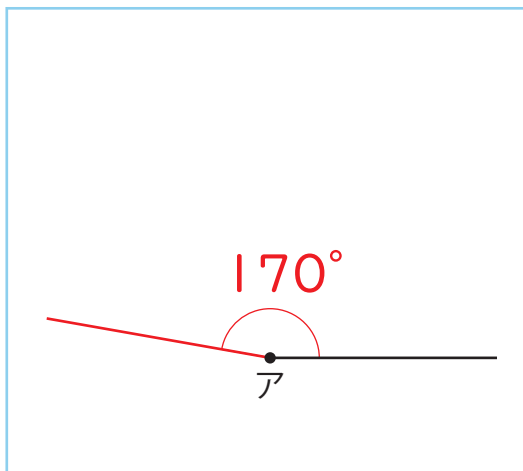

3 120°

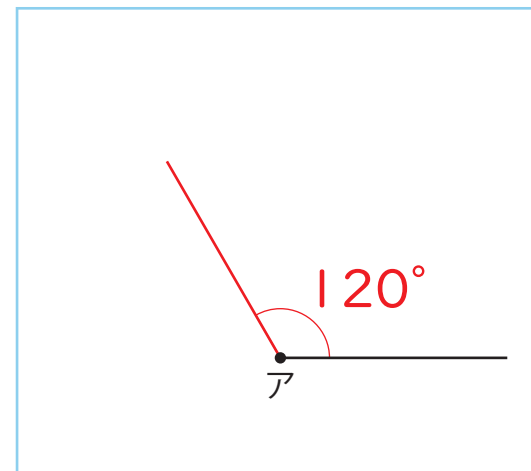

4 150°

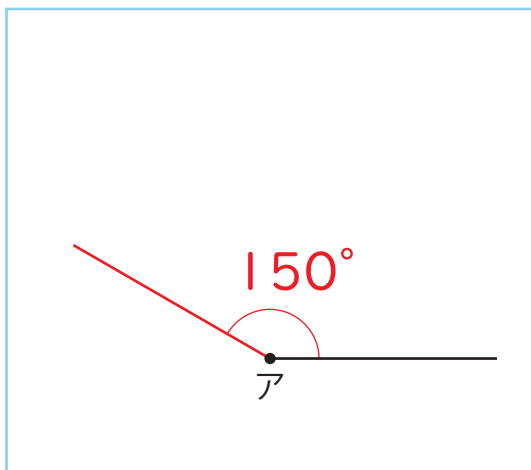

5 160°

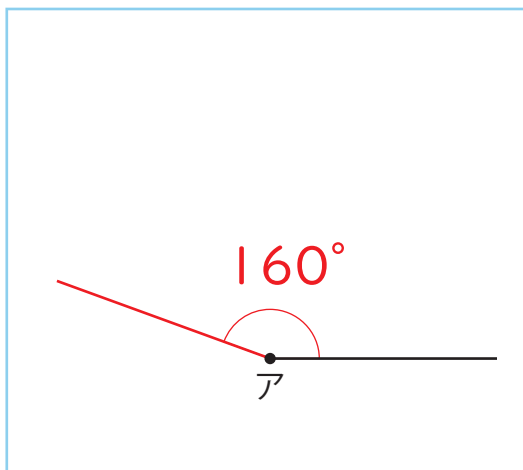

6 140°

